

RECOMMENDED TIGHTENING TORQUE:

55 Nm
5,5 kgf·m
41 ft·lbs

LOAD-DEFLECTION CURVE

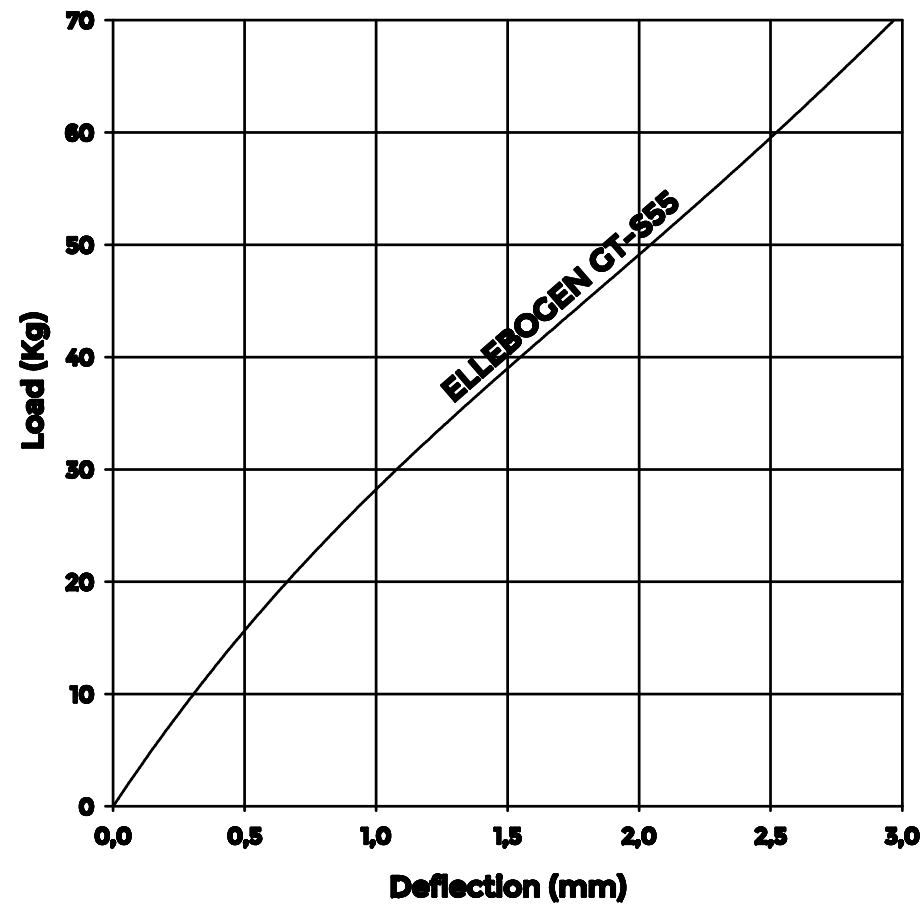

NATURAL FREQUENCY CURVE

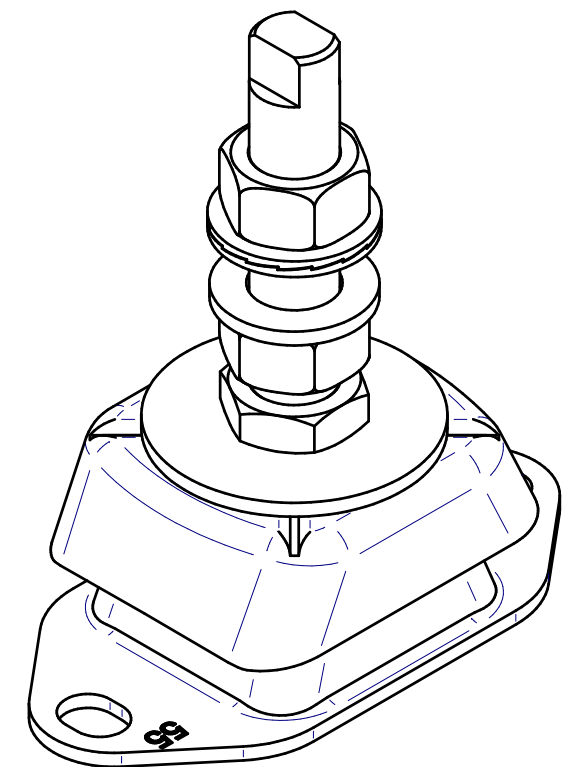
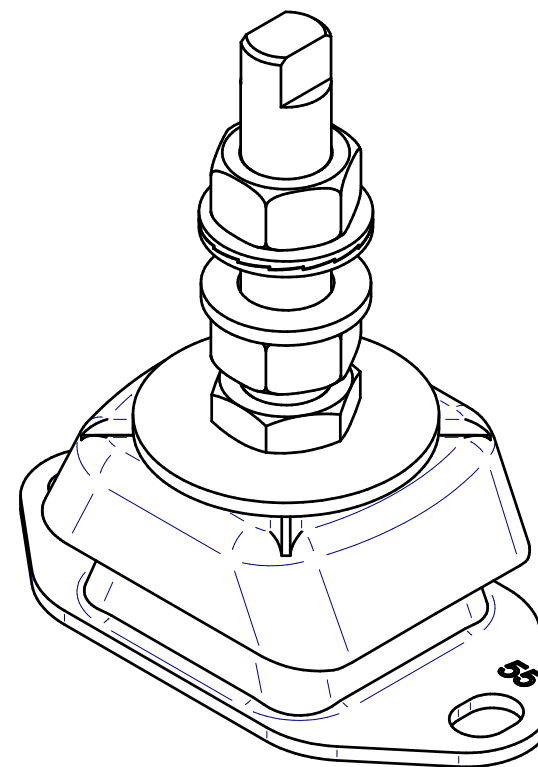
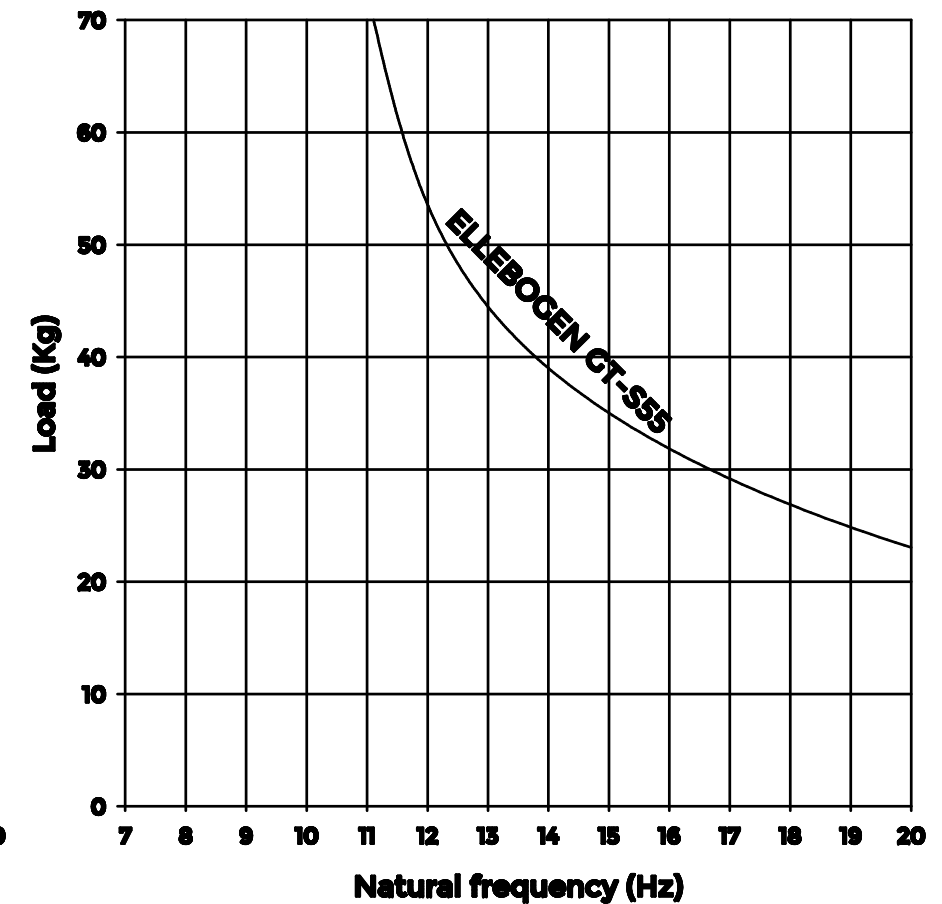

ELLEBOGEN

PROJECTION:

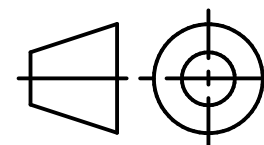

DESCRIPTION:

ELLEBOGEN GT-S55 MARINE ENGINE MOUNT

REF. NO.:

120450-06801

ESTIMATED WEIGHT:

0,736kg

REV.:

04

DRAWN:

R. E.

APPROVED:

I. J.

DATE:

15/12/2022

DATE:

15/12/2022

SCALE:

1:1,33

SHEET SIZE:

A3

GENERAL TOLERANCES ACC. TO ISO 2768-C

OVER (mm)	0,5	3	6	30	120	400	1000
UP TO (mm)	3	6	30	120	400	1000	2000
TOL. (mm)	±0,2	±0,3	±0,5	±0,8	±1,2	±2	±3

RUBBER TOLERANCES ACC. TO ISO 3302-M3

THIS DOCUMENT IS TO BE TREATED AS STRICTLY PRIVATE AND CONFIDENTIAL.

IT SHALL NOT BE DISCLOSED TO THIRD PARTIES WITHOUT PRIOR WRITTEN CONSENT.